

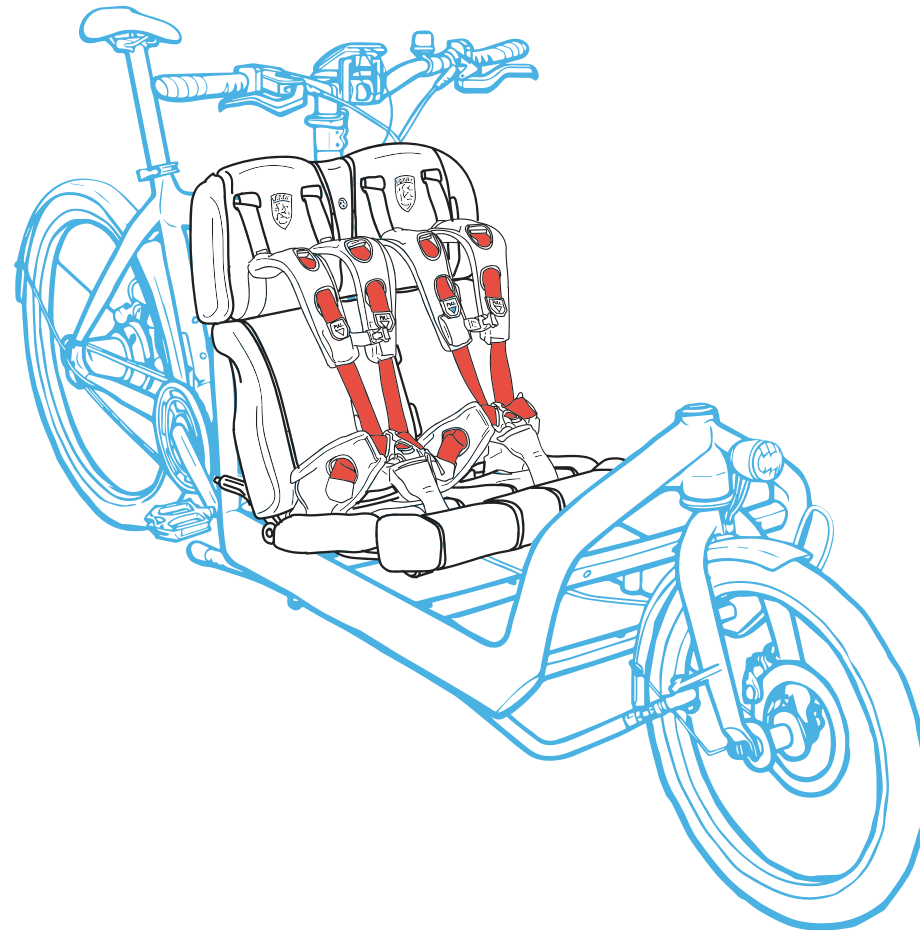

Twin Seat Assembly Manual



Before you start

Things you need to attach your Twin Seat

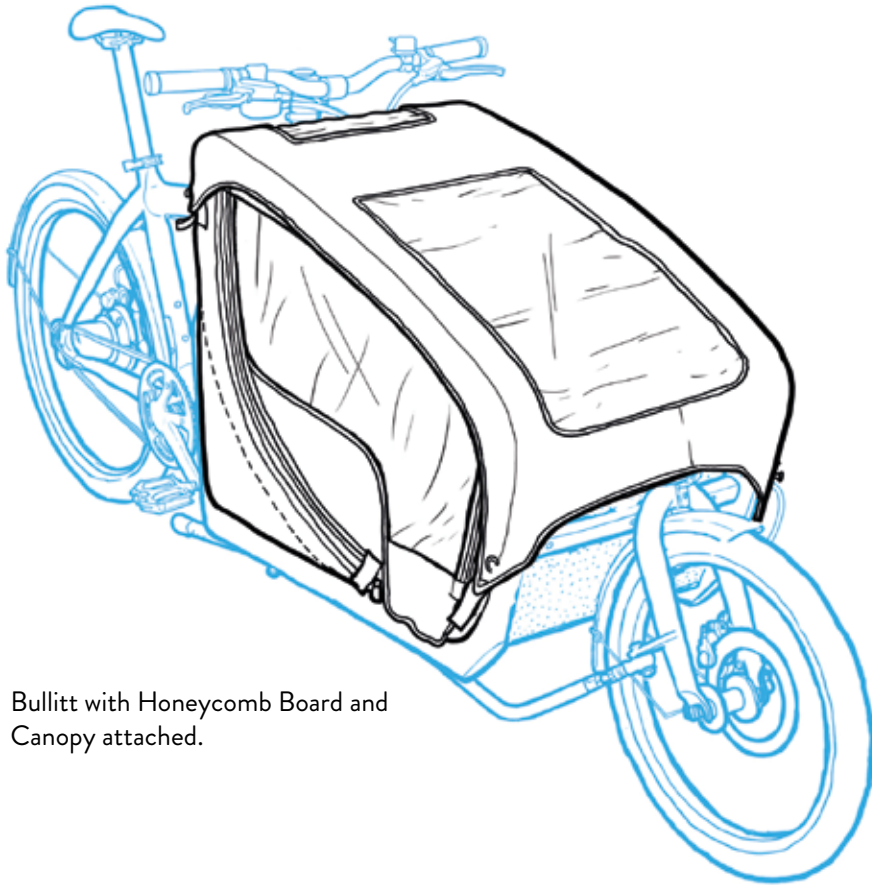





Bullitt with Honeycomb Board and Canopy attached.

You haven't mounted the Canopy yet?
Find the Canopy Assembly Manual in the Canopy Box or at larryvsharry.com/owners

Note: It is possible to attach Twin Seat without the Canopy, but you need the Honeycomb Board!

Tools you need

Find your tools and get ready!

- ① Phillips 3 Screwdriver

+
- ② 10mm Wrench/Spanner

- ③ 3mm Hex/Allen Key

- ④ Grease (metal on metal)

Icons that will appear throughout the guide:



Grease.

Remember to grease or else your mechanic will hate you later on.
("Muc-off" has a Bio Grease that cares about the environment)



Note!

Important message from Larry the King.

Components

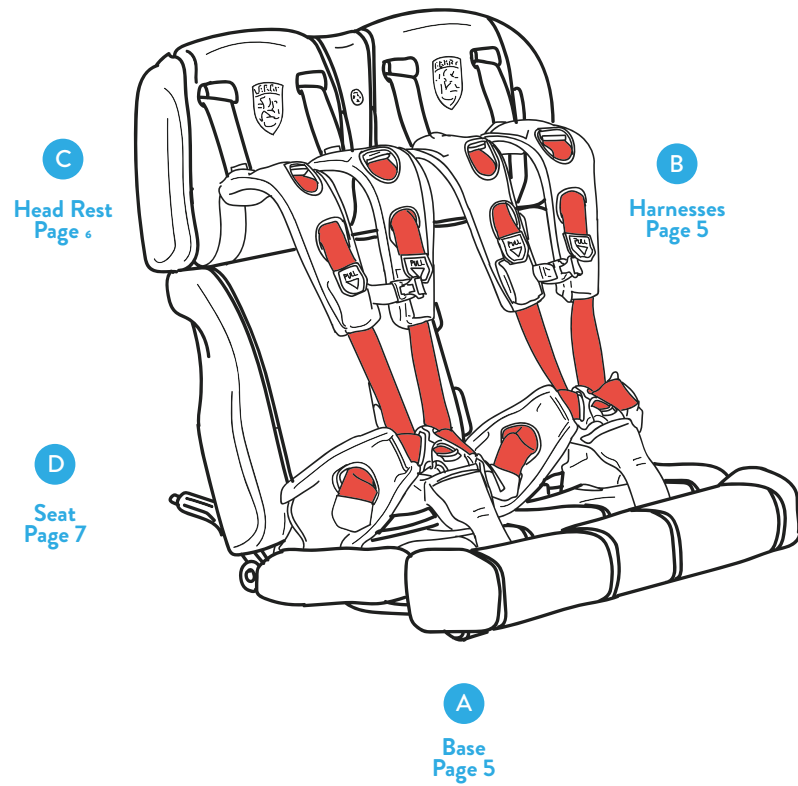

What's in the box?

Head Rest

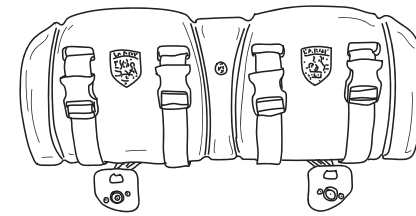

Seat

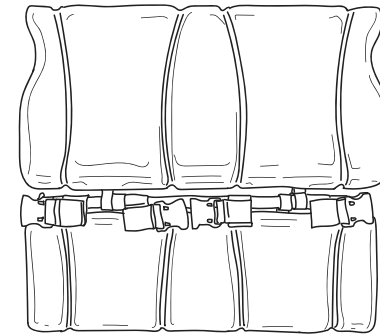

Base

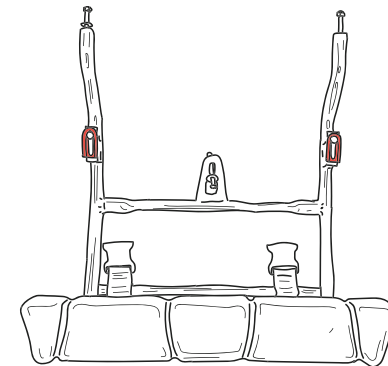

Two 5-point Harnesses

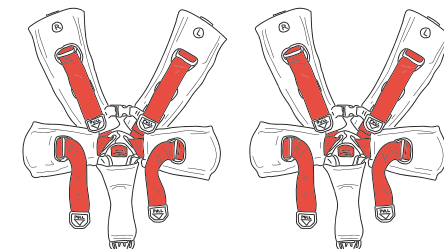

Step 1

Two tips before you start installing the Twin Seat, if you have the Foldable Seat mounted!

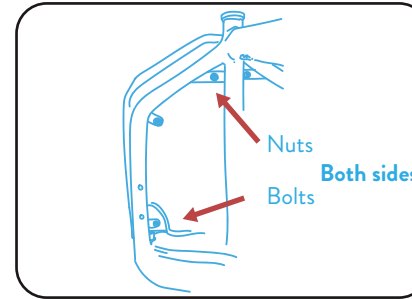
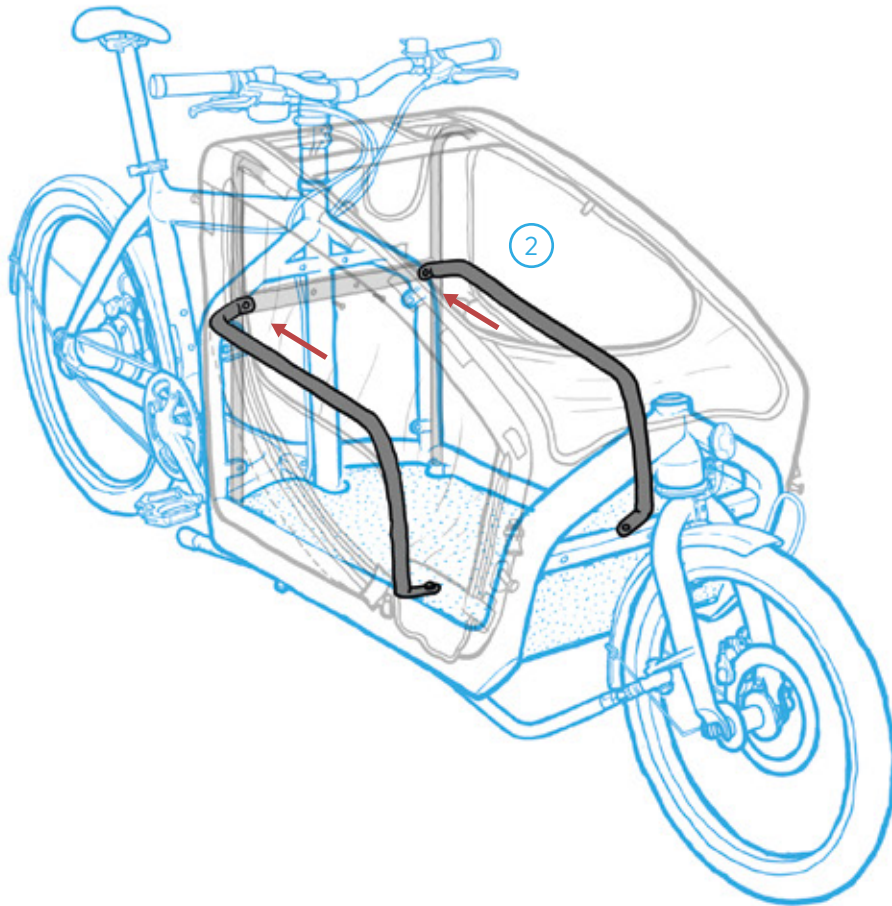

① Foldable Seat: Loosen 2 nuts and 2 bolts on the back of the Bullitt frame with 5mm Allen Key and 13mm Wrench.

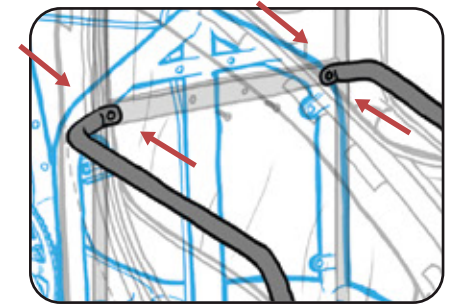

② Armrest in Canopy: Loosen 2 nuts on the armrest on the inside/ outside of the Canopy using 5mm Allen Key and 13mm Wrench.

Larry the King says:
"If you have installed the Bullitt Foldable Seat and want to replace it with the Twin Seat, you loosen the two bolts and two nuts and remove the Seat, before you follow the rest of the manual."



Step 2

Attaching the Base **A** + 5-point Harnesses **B**

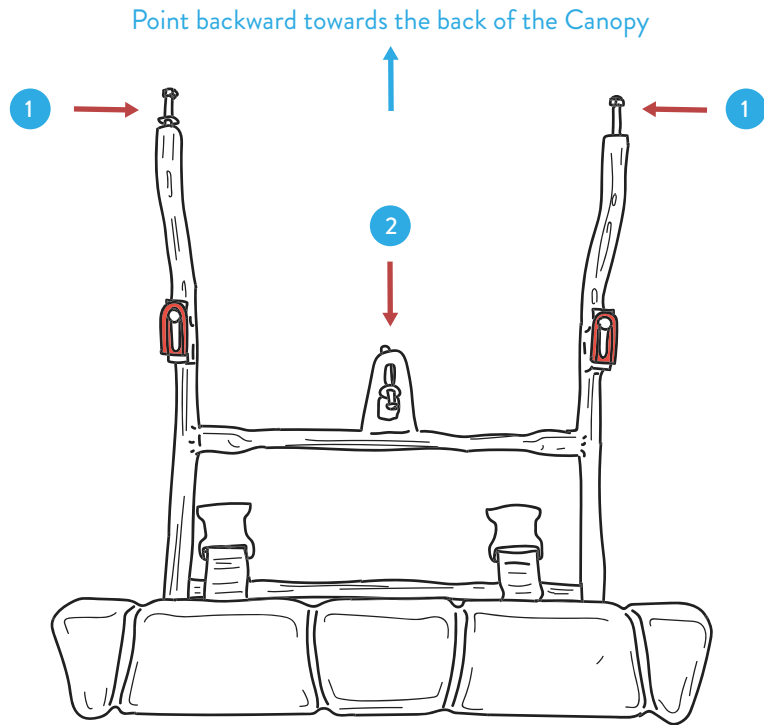

Point backward towards the back of the Canopy

Place Base (3) in the bottom, inside the Canopy

Point forward towards the headtube of the Bullitt

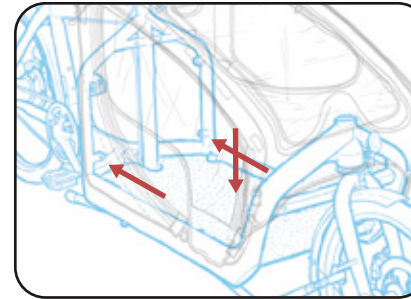

1 Align bolts with holes in the back (1) and in the center (2) of the Honeycomb Board.

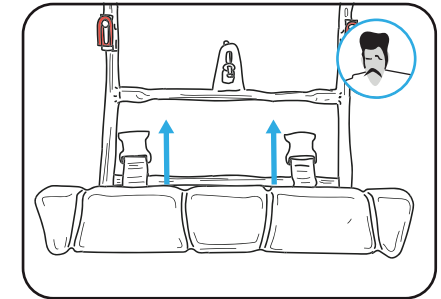

2 Note! Make sure the seat belt buckles point inwards (underneath the foamy part) before attaching the bolts.

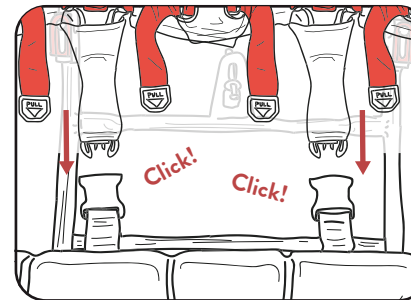

3 Attach the 5-point Harnesses to the buckles in the bottom. Fold them forward/up, so you can see what you are doing next.

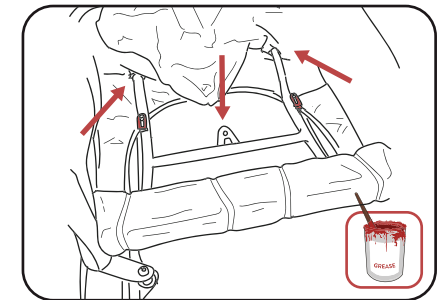

4 Grease your center bolt and mount it in the bottom center loosely so you can align the rest.

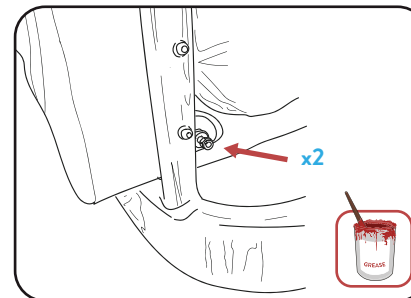

5 Mount the 2 bolts (from the back /outside of the Canopy) to the tubes (1). Add washers to the 2 bolts. Grease bolts.

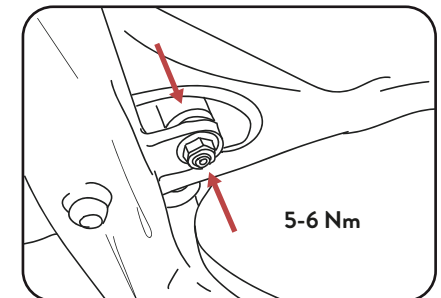

6 Tighten the nuts, so the Twin Seat tubes sits closely to the frame. Tighten the center bolt too.

Step 3

Attaching the Head Rest C

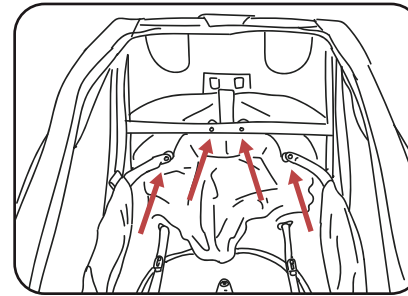
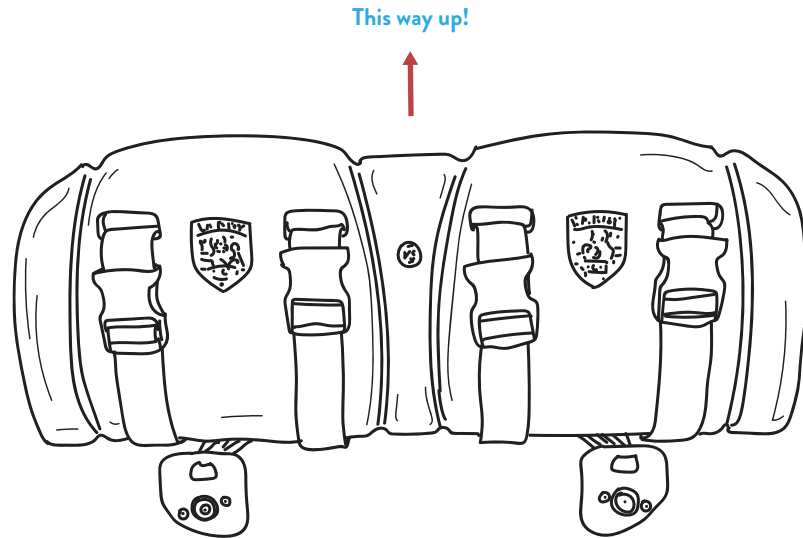

1 Align 4 holes on the back of the Canopy/armrests with the holes in the Bullitt frame.

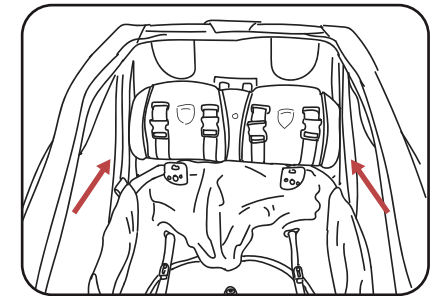

2 Align Head Rest with the 4 holes (make sure it turns the right way up). Slide the 4 bolts through the holes.



3 Grease bolts!

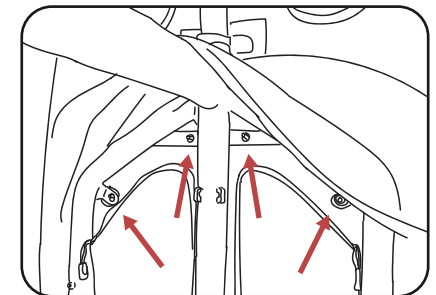

4 Add washers to the bolts. Put the 4 nuts from the back/ outside of the Bullitt frame onto the Head Rest bolts.

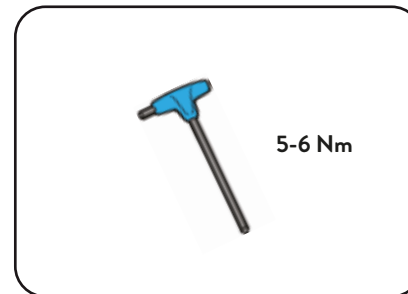

5 Tighten with 3mm Allen Key.

Step 4

Attaching the Seat D

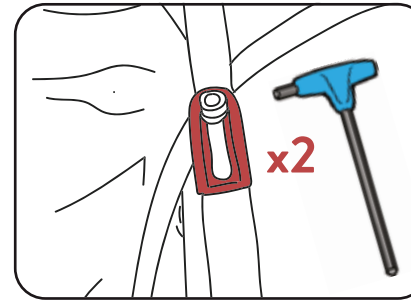
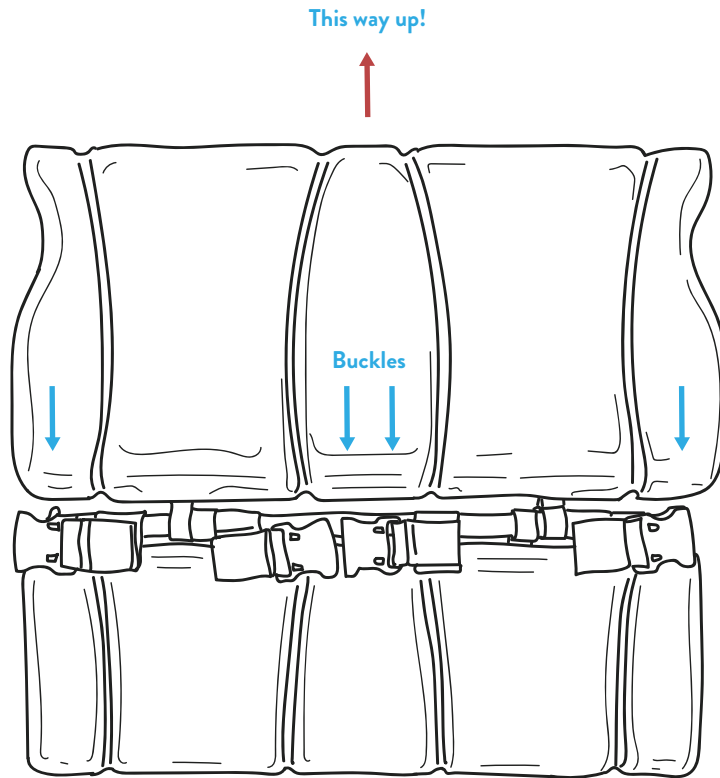

1 Loosen 2 bolts in the red adjustable mounts with a 5mm Allen Key.

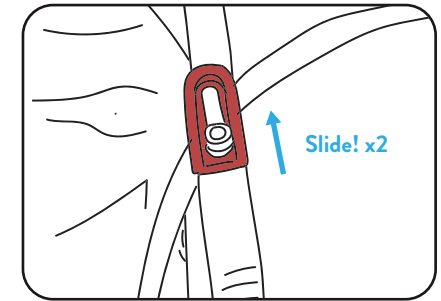

2 Slide the red adjustable mounts backwards.

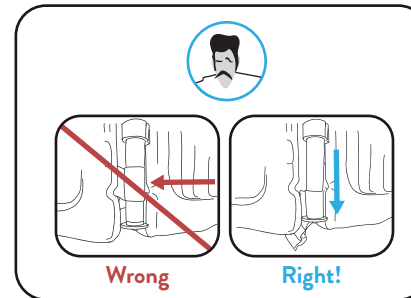

3 Before placing the Seat, turn the Seat around and make sure the seat belts are slid out to the sides of the tube!

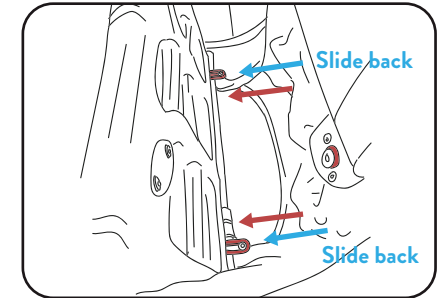

4 Put center-tube of the Seat in the notch close to the red mounts. Slide the red adjustable mounts back.

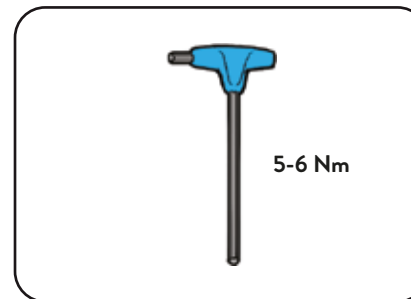

5 Tighten 2 bolts with 5mm Allen Key.

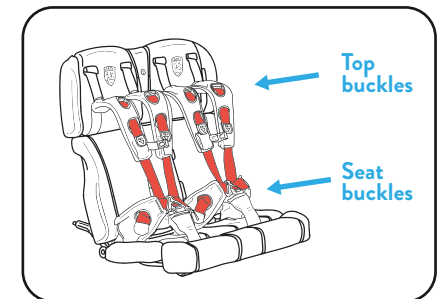

6 Attach the Harnesses to the buckles! That's 4 buckles for each belt: Two on the Seat, two on the Head Rest.

Extra Features

Nice features to note with the Twin Seat

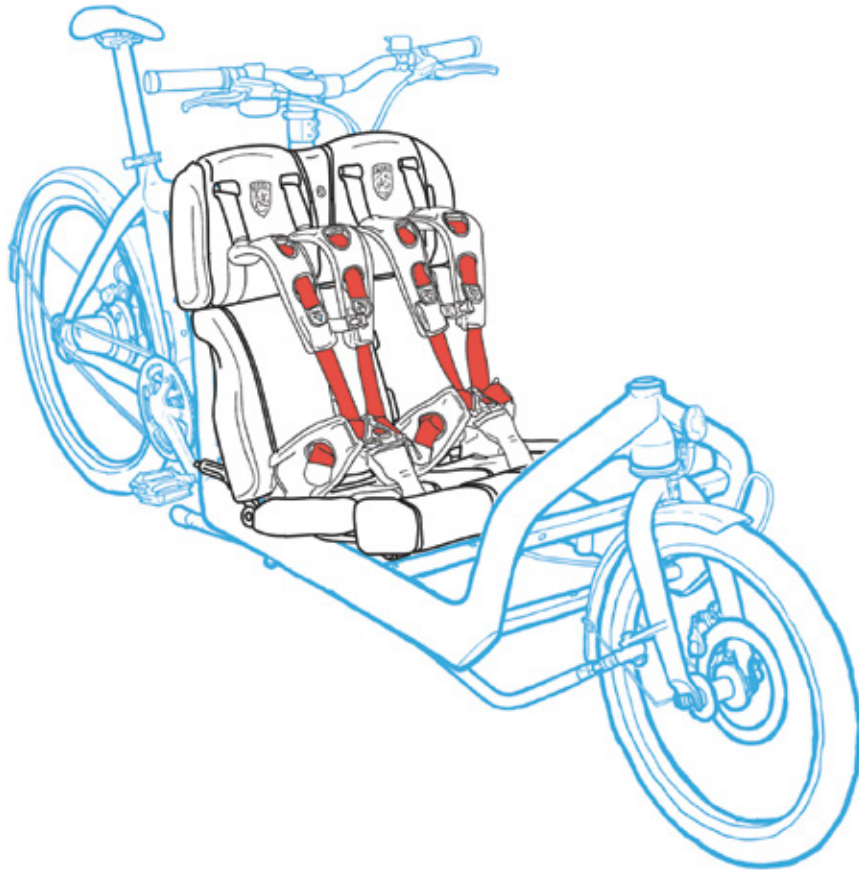

① The 5-point-Harnesses can easily be converted for use with one child for a more balanced ride.



①.1 The single kid 5-point-Harness is placed in the middle of the seat.

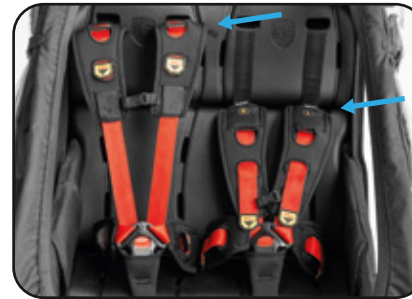

② Adjust the height of the harnesses by easily pulling the straps up or down by the top.



③ Small compartment room behind the seats for locks or things to make life easier - just pull the seat outwards.

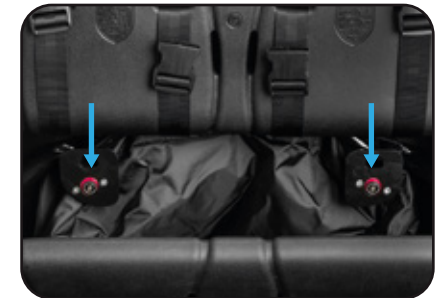

③.1 The compartment room is held together by very strong magnets.



Bullitt Copenhagen
Frederiksborggade 43, DK-1371 Copenhagen, Denmark

www.larryvsharry.com

All rights reserved © 2022 Larry vs Harry
Ver.No.: 01, 12-2021